

HARBINGER®

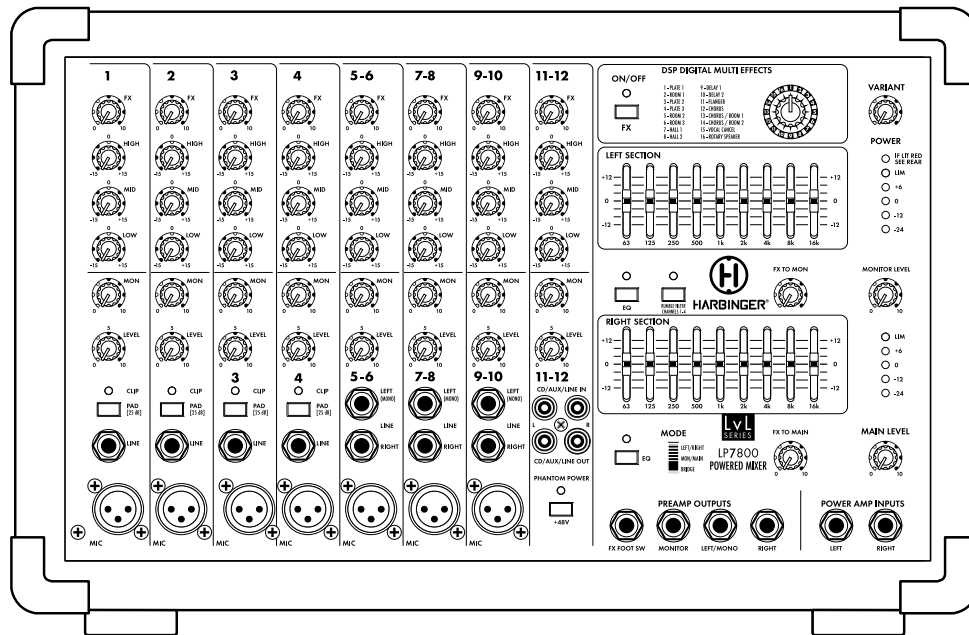

LvL
SERIES

LP7800
POWERED MIXER



WELCOME

Thank you for your purchase of this Harbinger® Powered Mixer. It's packed with quality features usually found only on larger, more expensive systems. To get the most from your new LP7800, take a moment and read through this entire manual to learn about all its important features.

Your new PA includes:

- 800W output power with Stereo, Main/Monitor, or Bridge Mono operation
- 7 XLR inputs with 48v Phantom power
 - 4 XLR mic/line channels with -25 dB pad and clip indicator
 - 3 XLR mic/stereo line channels
- Built-in effects with 24-bit DSP processor with 16 presets
- Two 9-band Graphic Equalizers
- 3-band EQ per channel
- Level control and bi-color Signal/Peak LED on 4 channels
- Stereo Output for recording, Stereo Input for CD/MP3 playback
- Monitor Send per channel

IMPORTANT SAFETY INSTRUCTIONS

DANGER

Exposure to extremely high noise levels may cause permanent hearing loss. Individuals vary considerably to noise-induced hearing loss but most will lose some hearing if exposed to intense noise for a sufficient period of time.

The U.S. Government's Occupational Safety and Health Administration (OSHA) has specified the following permissible noise level exposures:

DURATION PER DAY (HOURS)	8	6	4	3	2	1
SOUND LEVEL (dB)	90	93	95	97	100	103

According to OSHA, any exposure in the above permissible limits could result in some hearing loss. Ear plugs or protectors in the ear canal or over the ears must be worn when operating this amplification system in order to prevent a permanent hearing loss. If exposure in excess of the limits as put forth above, to insure against potentially harmful exposure to high sound pressure levels, it is recommended that all persons exposed to equipment capable of inducing high sound pressure levels, such as this amplification system, be protected by hearing protectors while this unit is in operation.

CAUTION
RISK OF ELECTRIC SHOCK
DO NOT OPEN

CAUTION: To reduce the risk of electric shock, do not remove chassis. No user-serviceable parts inside. Refer servicing to qualified service personnel.

THIS SYMBOL IS INTENDED TO ALERT THE USER TO THE PRESENCE OF NON-INSULATED "DANGEROUS VOLTAGE" WITHIN THE PRODUCT'S ENCLOSURE THAT MAY BE OF SUFFICIENT MAGNITUDE TO CONSTITUTE A RISK OF ELECTRIC SHOCK TO PERSONS

THIS SYMBOL IS INTENDED TO ALERT THE USER TO THE PRESENCE OF IMPORTANT OPERATING AND MAINTENANCE (SERVICING) INSTRUCTIONS IN THE LITERATURE ACCOMPANYING THE UNIT.

APPARATUS SHALL NOT BE EXPOSED TO DRIPPING OR SPLASHING AND THAT NO OBJECTS FILLED WITH LIQUIDS, SUCH AS VASES, SHALL BE PLACED ON THE APPARATUS.

IMPORTANT SAFETY INSTRUCTIONS

1. Read all safety and operating instructions before using this product.
2. All safety and operating instructions should be kept for future reference.
3. Read and understand all warnings listed on the operating instructions.
4. Follow all operating instructions to operate this product.
5. This product should not be used near water, i.e. a bathtub, sink, swimming pool, wet basement, etc.
6. Use only a dry cloth to clean this product.
7. Do not block any ventilation openings. The product should not be placed flat against a wall or placed in a built-in enclosure that will impede the flow of cooling air.
8. Do not install this product near any heat sources, such as radiators, heat registers, stoves or any other apparatus (including heat-producing amplifiers) that produces heat.
9. Do not defeat the safety purpose of the polarized or grounding-type plug. A polarized plug has two blades with one wider than the other. A grounding-type plug has two blades and a third grounding prong. The wide blade or the third prong are provided for your safety. If the provided plug does not fit into your outlet, consult an electrician for replacement of the obsolete outlet.
10. Protect the power cord being walked on or pinched, particularly at plugs, convenience receptacles and the point where they exit from the apparatus. Do not break the ground pin of the power supply cord.
11. When a cart is used, use caution when moving cart/apparatus combination to avoid injury from tip-over.
12. Unplug this apparatus during lightning storms or when unused for long periods of time.
13. Care should be taken so that objects do not fall and liquids are not spilled into the unit through the ventilation ports or any other openings.
14. Refer all servicing to a qualified service professional. Servicing is required when the apparatus does not operate normally or has been damaged in any way, including damage to the power cord or plug, damage due to liquids spilled or objects dropped inside the unit, dropping the unit, or anything else that interrupts normal use of the unit.
15. **WARNING:** To reduce the risk of fire or electric shock, do not expose this apparatus to rain or moisture.
16. Protective Ground Terminal. The apparatus shall be connected to an AC main socket with a protective earth ground connection.



TABLE OF CONTENTS

Welcome	2
Important Safety Instructions	3
Basic Operation.....	4
Front and Rear Panel Diagrams	5
Front Panel.....	6
Rear Panel	11
Specifications	12
Signal Flow Diagram.....	13
Power Amplifier Diagram.....	14
Output Block Diagram	15
Warranty	16

BASIC OPERATION

- **Ensure the LP7800's AC power switch is turned off.**
- Place the LP7800 on the floor, a table, or a sturdy stand.
- Turn down all Level, Monitor Level, and Main Level Controls.
- Plug speakers into the rear panel speaker jacks.
NOTE: Speakers should be placed in a location that allows for unobstructed (line-of-sight) sound projection to the audience. In many venues, it is beneficial to place speakers on speaker stands for best results.
- Plug sources such as microphones, instruments, or CD/MP3 players into the front panel jacks.
- Turn AC Power switch to "On".
- Slowly turn the Main Level to 12 o'clock.
- Slowly turn the Level control on each input Channel up to the desired volume level.

FRONT AND REAR PANEL DIAGRAMS

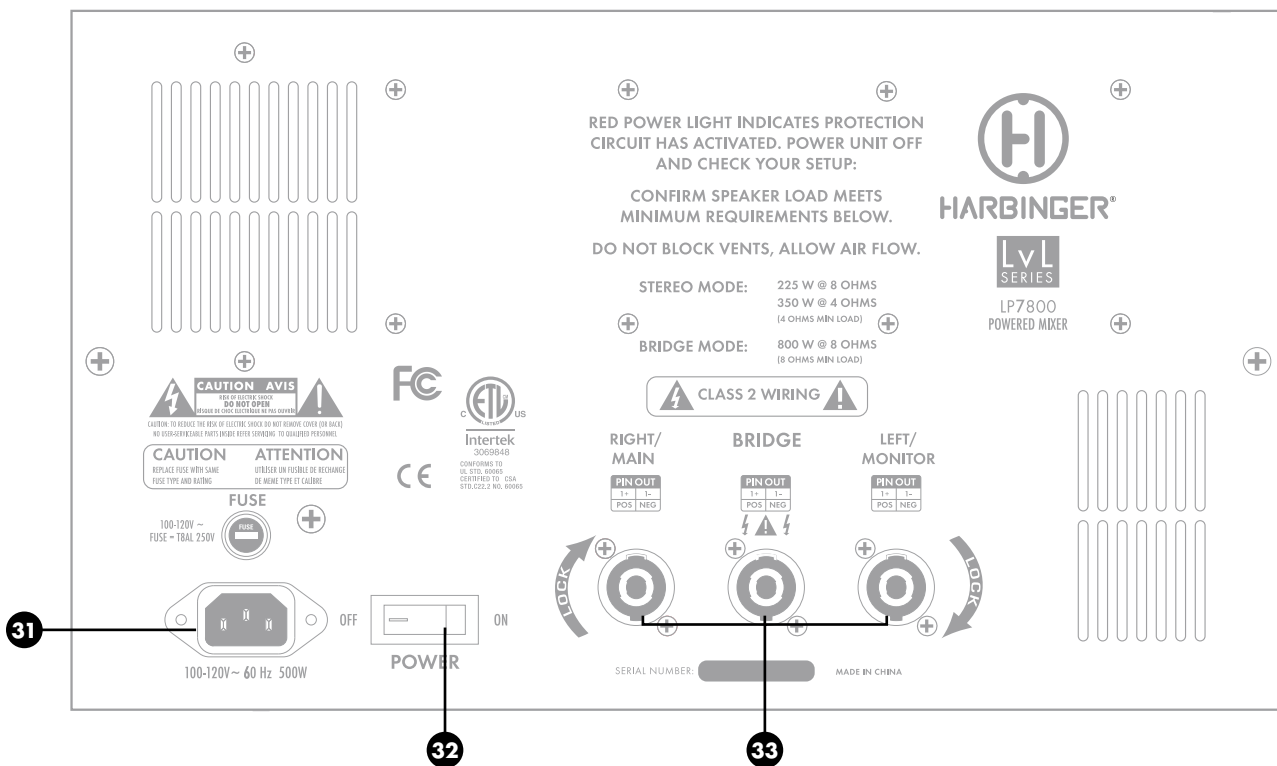
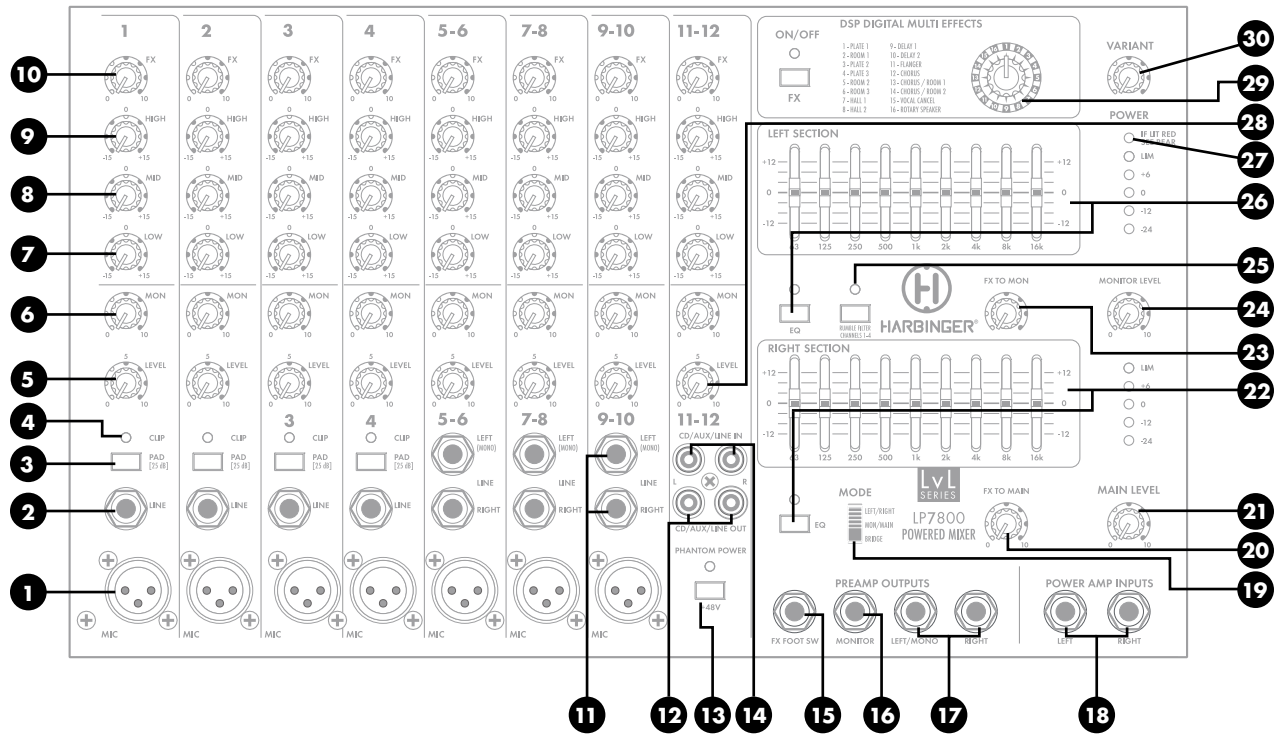

FRONT PANEL

- 1 XLR Mic Input Jack Channel 1-10**
Balanced. Appropriate for microphones, or direct out connections from amplifiers or DI boxes.



- 2 1/4" Line Input Jack Channel 1-4**
Balanced or Unbalanced. Appropriate for instrument or line level equipment connections.



- 3 Input Pad Channel 1-4**
Reduces the input signal by -25dB. Useful when the input signal is very strong and overdriving the input (causing the clip light to constantly flash or remain lit).

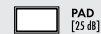

- 4 Peak LED**
This LED turns red when the input signal is clipping. If this occurs, lower the source signal output if possible.



- 5 Channel Level**
This is the volume control for individual input channels.



- 6 MON Send**
This control sends the input signal to the Monitor Line Out jack and assigned Monitor power amp (speaker output #2 when MAIN L+R / Monitor is selected in the Amplifier Assign section). See "Amplifiers Assign Switch" on page 8.



- 7 Low EQ**
This is the bass control used to boost or cut low frequencies on the input channel using a low shelf filter with +/- 15dB of boost or cut, below 60Hz. Useful for removing rumble on vocal or acoustic guitar inputs.

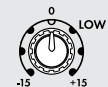

FRONT PANEL

8

Mid EQ

This is the mid range control used to boost or cut mid frequencies on the input channel, using a band filter with +/- 15dB, centered at 2kHz. This range will affect vocals and most instruments.



9

High EQ

This is the treble control used to boost or cut high frequencies on the input channel, using a high shelf filter with +/- 15dB of boost or cut above 10kHz. Useful for adding clarity to vocals or acoustic guitars, or removing hiss or unwanted cymbal pick-up.

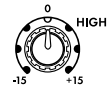

10

FX Send

This control sends the input signal to the built-in DSP FX processor. This controls the amount of FX used on each input channel.



11

Dual 1/4" Line Input Jack Channel 5-10

Balanced or Unbalanced. Appropriate for instrument or line level equipment connections.

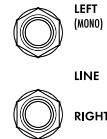

12

CD/AUX/LINE OUT

Unbalanced dual RCA outputs for connecting to MP3 recorders or computers. This connection has a fixed output that is fed from the MAIN output.



13

Phantom On/Off

This button is used when condenser microphones are connected to the LP7800, providing +48V to the XLR microphone inputs. Phantom power only applies to XLR input connections.

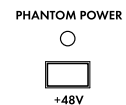

14

CD/AUX/LINE IN

Unbalanced inputs for CD/MP3 players. Use dual RCA jacks. These inputs are controlled by the Stereo In Level control and are fed to the Main volume.

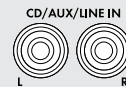

FRONT PANEL

15

Footswitch DSP Mute

Plug in a latching footswitch (not included) to turn the DSP Multi-FX on/off remotely. Useful to turn the FX off when talking, and back on when singing/playing.



FX FOOT SW

16

Monitor Out

Line level output controlled by the Monitor or Main Level knob to send the signal to external amplifiers or powered speakers.



MONITOR

17

Left / Right Main Out

Line level output controlled by the Monitor or Main Level knob to send the signal to external amplifiers or powered speakers.



LEFT/MONO

RIGHT

18

Power Amp Inputs

You can connect directly to the power amp via these jacks, overriding the normal connection from the internal mixer.

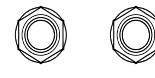

LEFT/MONO

RIGHT

19

Amplifiers Assign Switch

The LP7800 features 225W@8Ω, 350W4Ω or 800W@8Ω Mono Bridged

Note: The Mode switch is recessed to help avoid accidental changes when the amplifier is being used. To change modes, turn off the amp and use a flat-wedged screwdriver to change the assignment.

MAIN L – MAIN R

- Stereo Mode
- Output 1 is Left signal
- Output 2 is Right signal
- Monitor outputs to Monitor Out jack only
- 4Ω minimum speaker load per output

MAIN L+R – MONITOR

- Dual Mono Mode
- Output 1 is Main
- Output 2 is Monitor
- 4Ω minimum speaker load per output

Bridge – Bridge

- Amplifier 1 and 2 combine into a single, larger amplifier (Mono)
- Bridge Output is typically used for subwoofer, with Main and Monitor Line Outputs connected to powered speakers
- 8Ω minimum speaker load

MODE

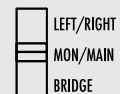

20

FX to Main Level

This control sends a signal from the FX/Aux return to the Main speakers and Main Line Output.



FX TO MAIN

FRONT PANEL

- 21 Main Level**
This knob controls the overall output level delivered to the speakers.

MAIN LEVEL



- 22 Monitor & Main 9-Band Graphic EQ**
Graphic Equalizer contains 9 filters that each cut or boost +/- 12dB around their center frequency. These filters can be used to contour the overall sound of all inputs, and reduce feedback (cut only). LED per EQ band. Press EQ button to engage Equalizer

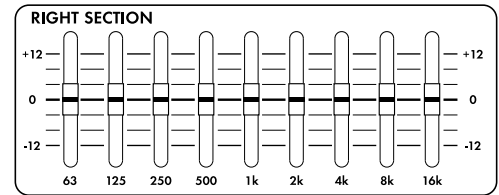

- 23 FX to Mon Level**
This control sends a signal from the FX/Aux return.

FX TO MON



- 24 Monitor Level**
This knob controls the output level of the Monitor Out jack. Each input Level control feeds both the Main Out (power amp) and Monitor Line Out.

MONITOR LEVEL



- 25 Rumble Filter**
This switch engages a low cut filter on channels 1-4 to reduce unwanted low frequency rumble vibration in the mic stand or cable.



- 26 Main 9-Band Graphic EQ**
Graphic Equalizer contains 9 filters that each cut or boost +/- 12dB around their center frequency. These filters can be used to contour the overall sound of all inputs, and reduce feedback (cut only). LED per EQ Band. Press EQ button to engage Equalizer

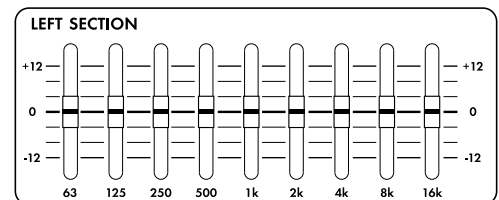

FRONT PANEL

Power/Protection LED

27

This LED is lit blue when the unit is powered on and functioning normally. If lit red, the built-in protection circuit has activated. Please consult rear of unit for troubleshooting tips and avoid incompatible speaker load, blocked vents, lack of airflow, or extreme heat.

○ IF LIT RED
SEE REAR

Stereo-In Level

28

This is the volume level for any devices connected to the CD/AUX inputs. The sound from CD/MP3 IN goes directly to the MAIN Output.



DSP Program

29

This knob is used to select the 16 preset FX programs from the built-in 24-bit DSP FX processor. Turn the knob to the desired FX preset.

DSP 24-BIT FX PRESET TABLE		
NO.	PRESET	PARAMETER
1	Plate 1	Reverb Delay Time: 50ms
2	Room 1	Decay Time: 50ms
3	Plate 2	Reverb Delay Time: 50ms
4	Plate 3	Reverb Delay Time: 80ms
5	Room 2	Decay Time: 50ms
6	Room 3	Decay Time: 80ms
7	Hall 1	Decay Time: 50ms
8	Hall 2	Decay Time: 80ms
9	Delay 1	Delay Time: 100mS
10	Delay 2	Delay Time: 300mS
11	Flanger	Decay Time: 50mS
12	Chorus	Rate: 44.1K
13	Chorus/Room 1	Rate: 22K
14	Chorus/Room 2	Rate: 44.1K
15	Vocal Cancel	
16	Rotary Speaker	Modulation Depth: 6dB

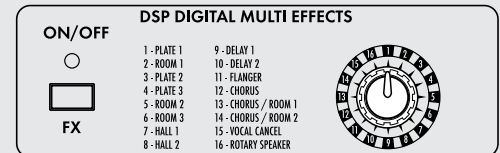

Variant Knob

30

This knob changes the character of the effect depending on the effect type. It either changes the length of a reverb, the feedback/repeat amount of a delay, or the depth of a modulation effect. See the preset descriptions above for more information on how this control works.

VARIANT



REAR PANEL

31

AC Power Cord Input

This is the AC Mains connection. Use only the supplied IEC cable or a UL listed replacement IEC Cable and 100-120V/60Hz switching power supply.

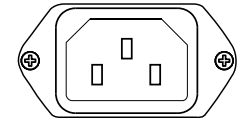

100-120V ~ 60 Hz 500W

32

On Off Switch

This switch turns on the LP7800 and off. When powered on the blue power led will light.



33

Speaker Outputs

L/Monitor Connect up to two (2) loudspeakers to the speaker output jacks. Note that the LP7800 power amp is rated at 4Ω Minimum Load. You may safely connect 2 x 8Ω speakers or 1 x 4Ω speaker.

Bridge Output (Mono) Connect one (1) 8Ω speaker to this output.

Note that damage may occur to the LP7800 if using Bridge Mode with more than one 8Ω speaker.

R/Main Connect up to two (2) loudspeakers to the speaker output jacks. Note that the LP7800 power amp is rated at 4Ω Minimum Load. You may safely connect 2 x 8Ω speakers or 1 x 4Ω speaker.

*Note: Twist-lock outputs are configured 1+ (pos)/1- (neg).
If Bridge Mono is used, no speakers should be connected to Right/Main or Left Monitor*

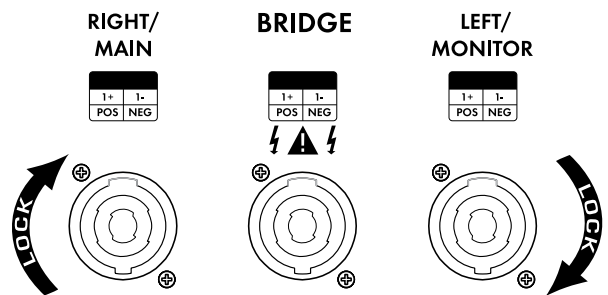



SPECIFICATIONS

Power Amplifier (Output):		
Input Channels	Microphone Inputs	-60dBu
	Frequency Response	20Hz-20KHz(±1dB)
	Gain	36dB
	Line Inputs	-50dBu
	Frequency Response	20Hz-20KHz(±0.5dB)
	Gain	24dB
Impedance	Microphone Input	2.2KΩ balanced/ 1.1KΩ unbalanced
	All Other Inputs	47KΩ unbalanced
	Tape Out	120Ω
	All Other Outputs	100Ω
Equalization	High Shelving	10KHz ±15dB
	Mid Shelving	2KHz ±15dB
	Low Shelving	60Hz ±15dB
	Graphic EQ	65Hz/125Hz/250Hz/500Hz/1KHz/2KHz/4KHz/8KHz/16KHz (±12dB)
DSP section	A/D and D/A Converters	YES
	DSP Resolution	24BIT
	Type of Effects	AL3201
	Presets	YES
	Controls	encoder
Main Mix Section	Noise (Bus noise)	≤0.5mV
	Monitor Max Out	+21dBu
	FX Sends Max Out	+21dBu
	Total Harmonic Distortion	1%
	Signal to Noise Ratio	90dB
	Static Power Consumption	50W
	Power Source	115V-50/60Hz

SIGNAL FLOW DIAGRAM

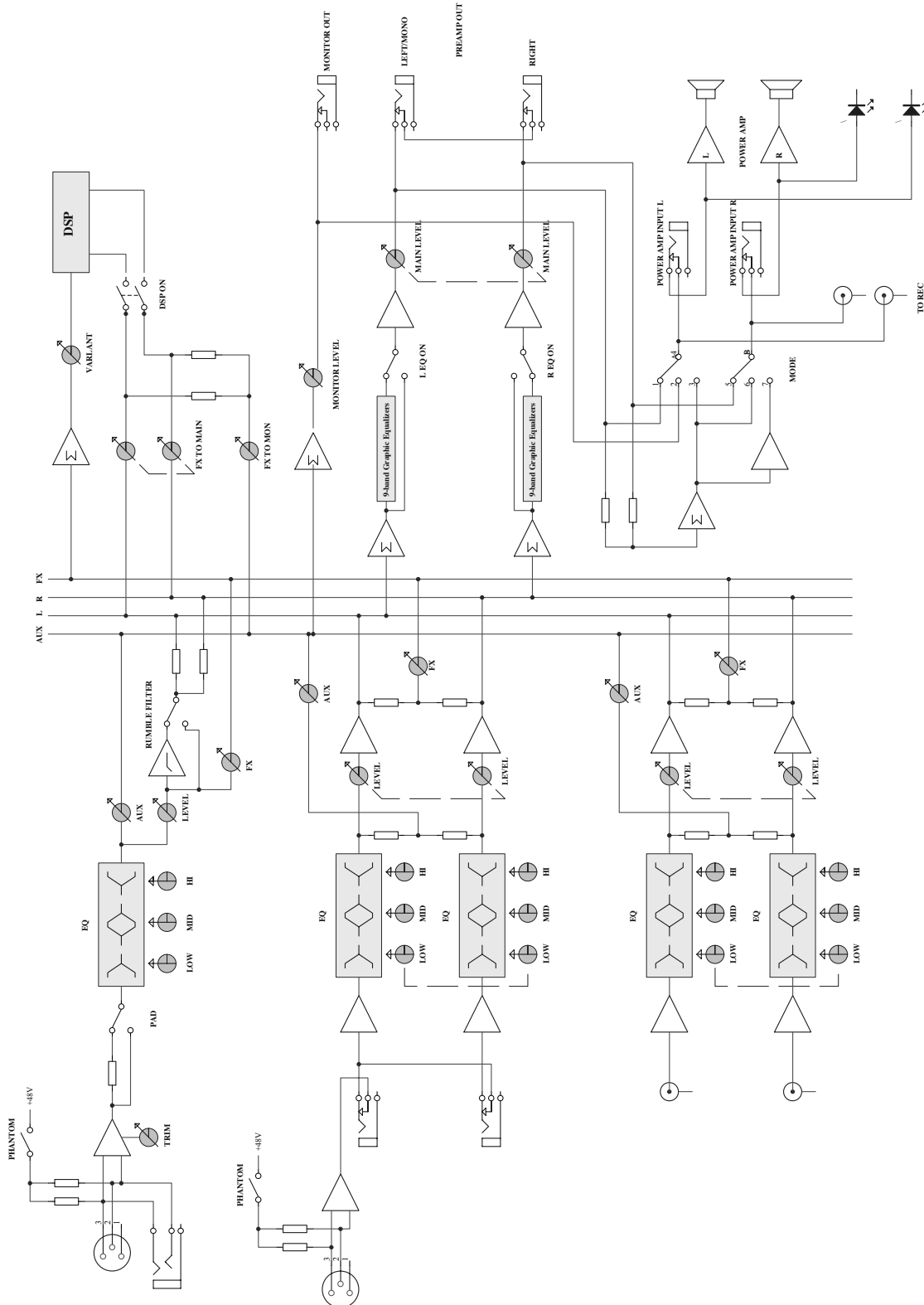

POWER AMPLIFIER DIAGRAM

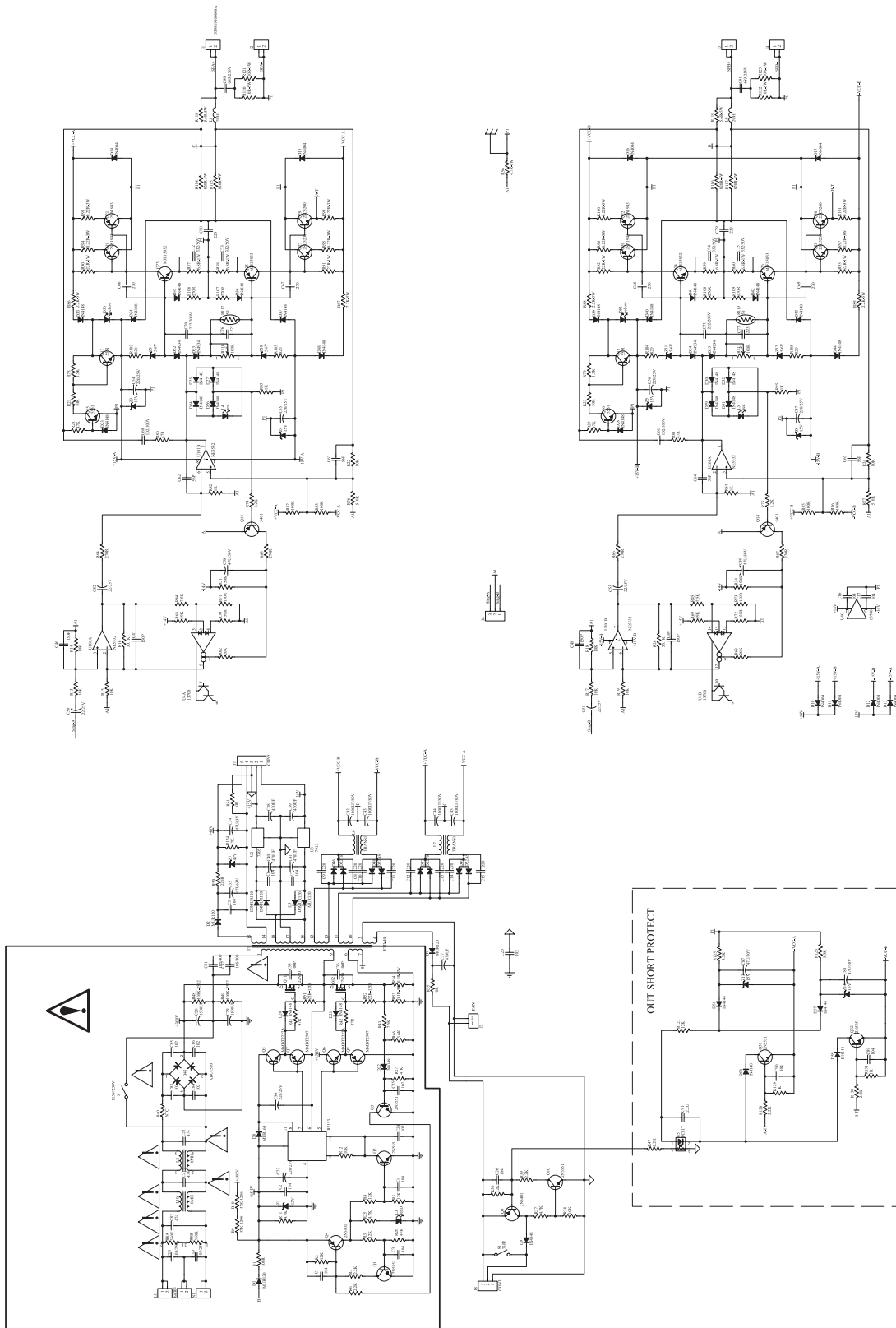

OUTPUT BLOCK DIAGRAM

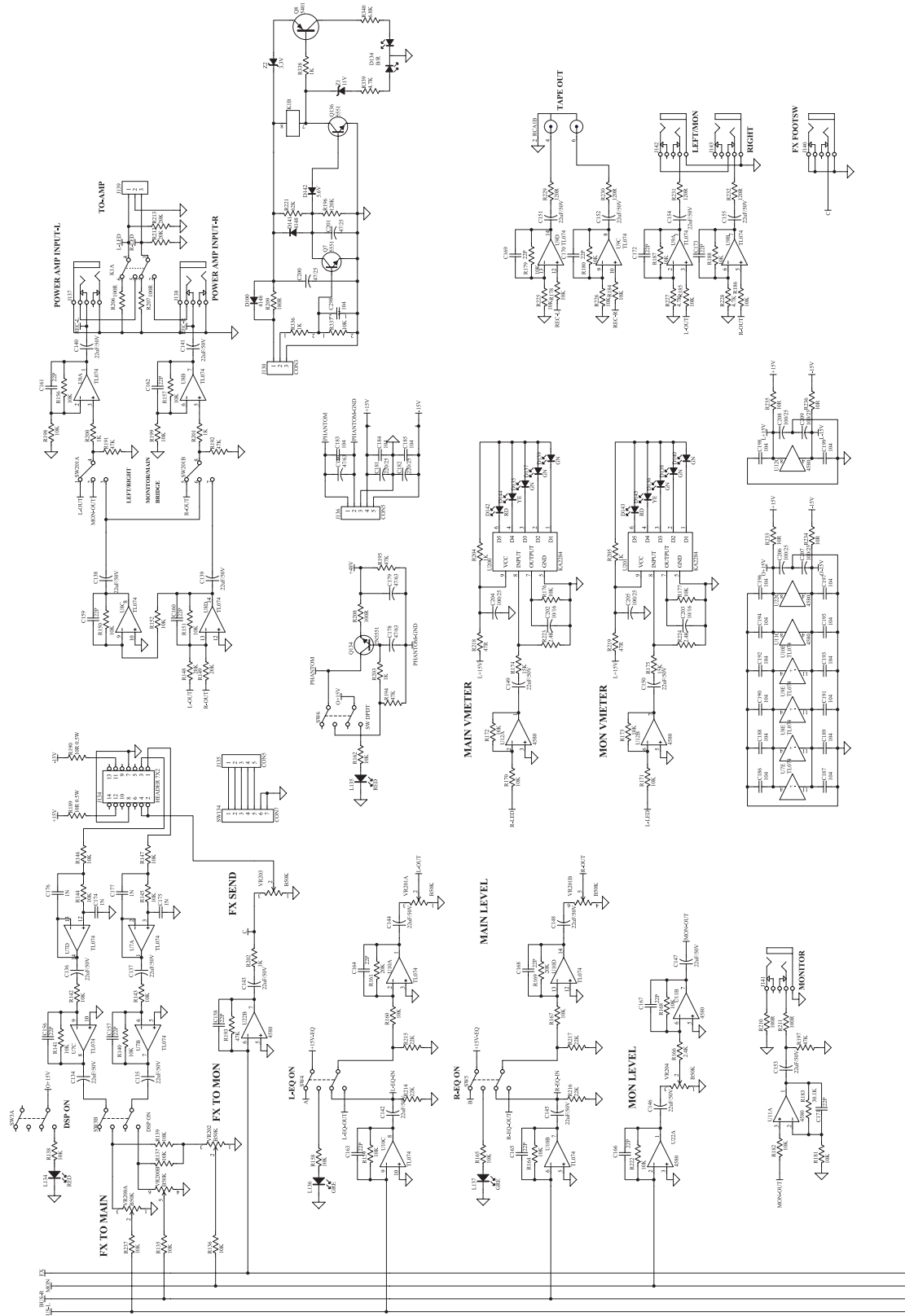

WARRANTY

Have a question about service, warranty or parts?

Call **888-286-1809** (Toll Free)

So we may serve you better, please register on-line at www.HarbingerProAudio.com

2 YEAR HARBINGER LIMITED WARRANTY

Harbinger provides, to the original purchaser, a two (2) year limited warranty on materials and workmanship on all Harbinger cabinets, loudspeaker and amplifier components from the date of purchase.

For warranty support, please visit our website at www.HarbingerProAudio.com, or contact our Support Team at **888-286-1809** for assistance. Harbinger will repair or replace the unit at Harbinger's discretion.

This warranty does not cover service or parts to repair damage caused by neglect, abuse, normal wear and tear and cosmetic appearance to the cabinetry not directly attributed to defects in materials or workmanship. Also excluded from coverage are damages caused directly or indirectly due to any service, repair(s), or modifications of the cabinet, which has not been authorized or approved by Harbinger. This two (2) year warranty does not cover service or parts to repair damage caused by accident, disaster, misuse, abuse, burnt voice-coils, over-powering, negligence, inadequate packing or inadequate shipping procedures.

The sole and exclusive remedy of the foregoing limited warranty shall be limited to the repair or replacement of any defective or non-conforming component. All warranties including, but not limited to, the express

warranty and the implied warranties of merchantability and fitness for a particular purpose are limited to the two (2) year warranty period. Some states do not allow limitation on how long an implied warranty lasts, so the above limitation may not apply to you. There are no express warranties beyond those stated here. In the event that applicable law does not allow the limitation of the duration of the implied warranties to the warranty period, then the duration of the implied warranties shall be limited to as long as is provided by applicable law. No warranties apply after that period.

Retailer and manufacturer shall not be liable for damages based upon inconvenience, loss of use of product, loss of time, interrupted operation or commercial loss or any other incidental or consequential damages including but not limited to lost profits, downtime, goodwill, damage to or replacement of equipment and property, and any costs of recovering, reprogramming, or reproducing any program or data stored in equipment that is used with Harbinger products. This guarantee gives you specific legal rights; you may have other legal rights, which vary from state to state.

Harbinger P.O. Box 5111, Thousand Oaks, CA 91359-5111

All trademarks and registered trademarks mentioned herein are recognized as the property of their respective holders.

FCC STATEMENTS

1. Caution: Changes or modifications to this unit not expressly approved by the party responsible for compliance could void the user's authority to operate the equipment.
2. Note: This equipment has been tested and found to comply with the limits for a Class B digital device, pursuant to Part 15 of the FCC Rules. These limits are designed to provide reasonable protection against harmful interference in a residential installation. This equipment generate, uses, and can radiate radio frequency energy and, in not installed and used in accordance with the instructions, may cause harmful interference to radio communications. However, there is no guarantee that interference will not occur in a particular installation. If this

equipment does cause harmful interference to radio or television reception, which can be determined by turning the equipment off and on, the user is encouraged to try to correct the interference by one or more of the following measures:

- Reorient or relocate the receiving antenna
- Increase the separation between the equipment and receiver
- Connect the equipment into an outlet on a circuit different from that to which the receiver is connected
- Consult the dealer or an experienced radio/TV technician for help

